

Typical Applications

The HMC252QS24 / HMC252QS24E is ideal for:

- Base Station
- CATV / DBS
- MMDS & WirelessLAN
- Test Equipment

Features

- Low Insertion Loss (2 GHz): 0.9 dB
- Single Positive Supply: $V_{dd} = +5V$
- Integrated 3:6 TTL Decoder
- 24 Lead QSOP Package

Functional Diagram

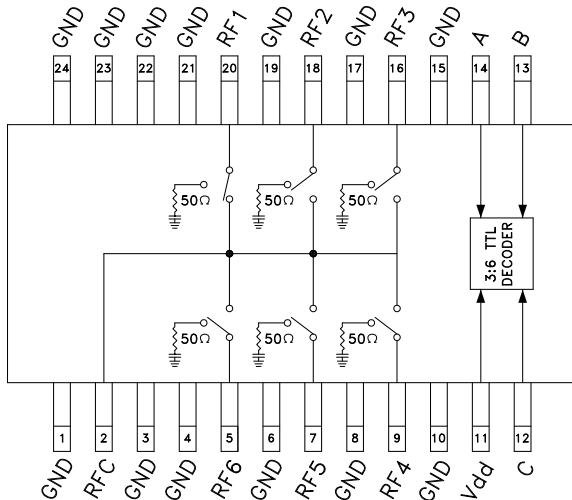

General Description

The HMC252QS24 & HMC252QS24E are low-cost non-reflective SP6T switches in 24-lead QSOP packages featuring wideband operation from DC to 3.0 GHz. The switch offers a single positive bias and true TTL/CMOS compatibility. A 3:6 decoder is integrated on the switch requiring only 3 control lines and a positive bias to select each path. The HMC252QS24 & HMC252QS24E SP6T replaces multiple configurations of SP4T and SPDT MMIC switches and logic drivers.

Electrical Specifications,

$T_A = +25^\circ C$, For TTL Control and $V_{dd} = +5V$ in a 50 Ohm System

Parameter	Frequency	Min.	Typ.	Max.	Units
Insertion Loss	DC - 1.0 GHz		0.8	1.2	dB
	DC - 2.0 GHz		0.9	1.3	dB
	DC - 2.5 GHz		1.0	1.5	dB
	DC - 3.0 GHz		1.3	1.8	dB
Isolation	DC - 1.0 GHz	38	41		dB
	DC - 2.0 GHz	32	35		dB
	DC - 2.5 GHz	29	32		dB
	DC - 3.0 GHz	26	29		dB
Return Loss	"On State"	DC - 2.5 GHz	14	18	dB
		DC - 3.0 GHz	7	12	dB
Return Loss	RF1-6 "Off State"	0.3 - 3.0 GHz	8	12	dB
		0.5 - 2.5 GHz	11	15	dB
Input Power for 1dB Compression	0.3 - 3.0 GHz	21	24		dBm
Input Third Order Intercept (Two-Tone Input Power = +7 dBm Each Tone)	0.3 - 3.0 GHz	42	46		dBm
Switching Characteristics	0.3 - 3.0 GHz	tRISE, tFALL (10/90% RF)	35		ns
		tON, tOFF (50% CTL to 10/90% RF)	120		ns

Insertion Loss

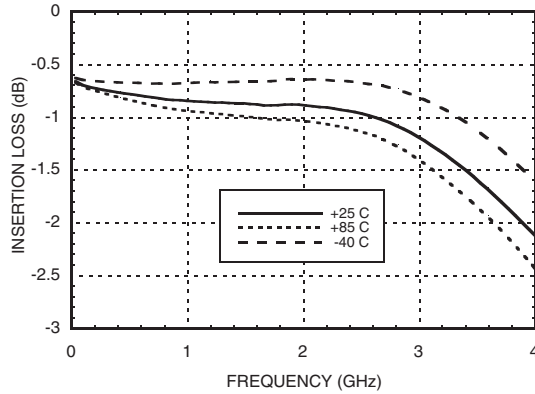

Isolation

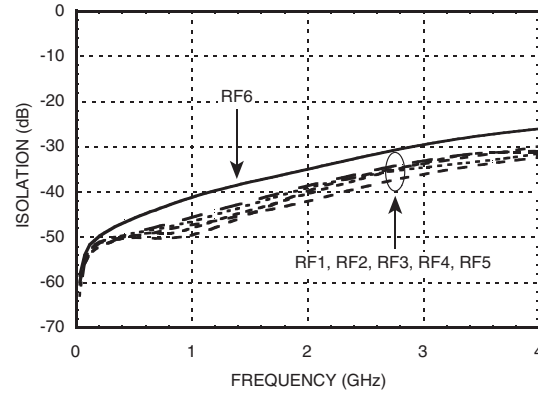

Return Loss

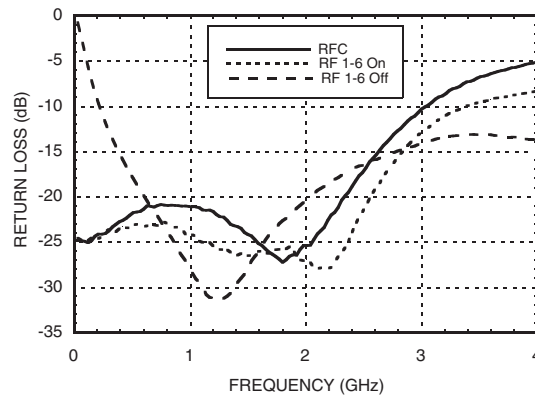

Bias Voltage & Current

Vdd Range = +5.0 Vdc ± 10%		
Vdd (Vdc)	Idd (Typ.) (mA)	Idd (Max.) (mA)
+5.0	5.0	8.0

Truth Table

Control Input			Signal Path State
A	B	C	RFCOM to:
LOW	LOW	LOW	RF1
HIGH	LOW	LOW	RF2
LOW	HIGH	LOW	RF3
HIGH	HIGH	LOW	RF4
LOW	LOW	HIGH	RF5
HIGH	LOW	HIGH	RF6
LOW	HIGH	HIGH	ALL OFF
HIGH	HIGH	HIGH	ALL OFF

TTL/CMOS Control Voltages

State	Bias Condition
Low	0 to +0.8 Vdc @ 5uA Typ.
High	+2.0 to +5.0 Vdc @ 70 uA Typ.

NOTE:

- DC Blocking capacitors are required at ports RFC and RF1, 2, 3, 4, 5, 6.
- Input is reflective when "ALL OFF" state is selected.

Absolute Maximum Ratings

Bias Voltage Range (Port Vdd)	+7.0 Vdc
Control Voltage Range (A, B, C)	-0.5V to Vdd +1 Vdc
Channel Temperature	150 °C
Thermal Resistance (Insertion Loss Path)	240 °C/W
Thermal Resistance (Terminated Path)	260 °C/W
Storage Temperature	-65 to +150 °C
Operating Temperature	-40 to +85 °C
Maximum Input Power Vdd = +5 Vdc	+20 dBm (0.05 - 0.5 GHz) +26 dBm (0.5 - 3.0 GHz)



ELECTROSTATIC SENSITIVE DEVICE
OBSERVE HANDLING PRECAUTIONS

Outline Drawing

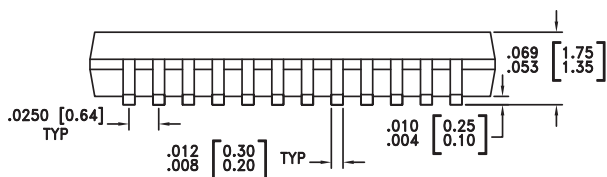
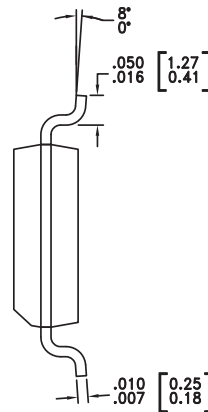
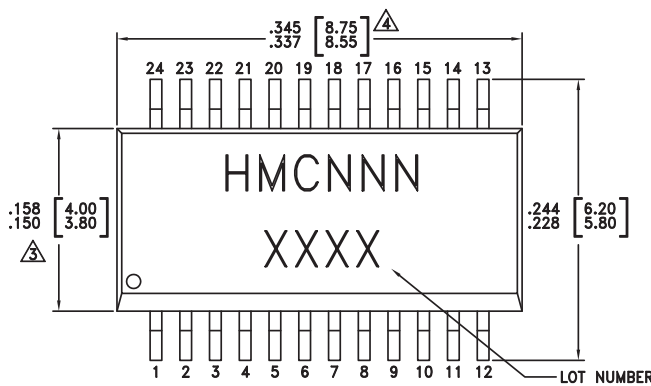

NOTES:

- LEADFRAME MATERIAL: COPPER ALLOY
- DIMENSIONS ARE IN INCHES [MILLIMETERS].
- DIMENSION DOES NOT INCLUDE MOLDFLASH OF 0.15mm PER SIDE.
- DIMENSION DOES NOT INCLUDE MOLDFLASH OF 0.25mm PER SIDE.
- ALL GROUND LEADS MUST BE SOLDERED TO PCB RF GROUND.

Package Information

Part Number	Package Body Material	Lead Finish	MSL Rating	Package Marking ^[3]
HMC252QS24	Low Stress Injection Molded Plastic	Sn/Pb Solder	MSL1 ^[1]	HMC252 XXXX
HMC252QS24E	RoHS-compliant Low Stress Injection Molded Plastic	100% matte Sn	MSL1 ^[2]	<u>HMC252</u> XXXX

[1] Max peak reflow temperature of 235 °C

[2] Max peak reflow temperature of 260 °C

[3] 4-Digit lot number XXXX

For price, delivery, and to place orders, please contact Hittite Microwave Corporation:
20 Alpha Road, Chelmsford, MA 01824 Phone: 978-250-3343 Fax: 978-250-3373
Order On-line at www.hittite.com

Evaluation Circuit Board

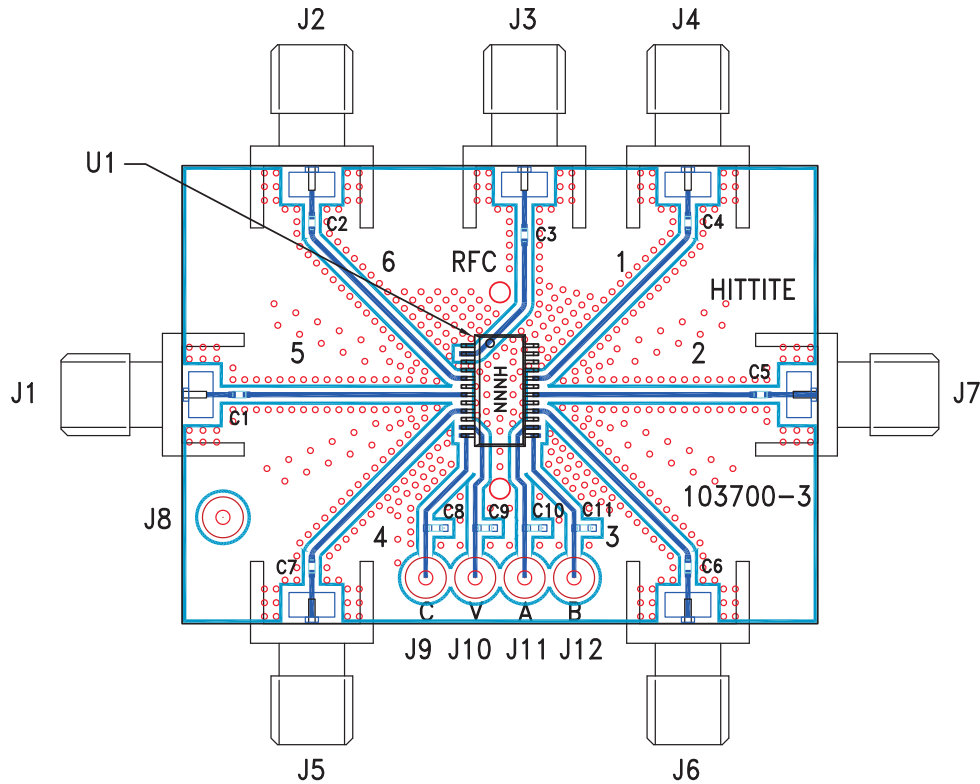

List of Materials for Evaluation PCB 101673 [1]

Item	Description
J1 - J7	PCB Mount SMA Connector
J8 - J12	DC Pin
C1 - C7	100 pF Capacitor, 0402 Pkg.
C8 - C11	10,000 pF Capacitor, 0603 Pkg.
U1	HMC252QS24 / HMC252QS24E SP8T Switch
PCB [2]	103700 Eval Board

[1] Reference this number when ordering complete evaluation PCB

[2] Circuit Board Material: Rogers 4350

The circuit board used in the final application should be generated with proper RF circuit design techniques. Signal lines at the RF ports should have 50 ohm impedance while the package ground leads should be connected directly to the ground plane similar to that shown above. A sufficient number of via holes should be used to connect the top and bottom ground planes. The evaluation circuit board shown above is available from Hittite Microwave Corporation upon request.